

PRICELIST 2017

แคตตาล็อก / ราคาสินค้า

Cable Ties and Accessories

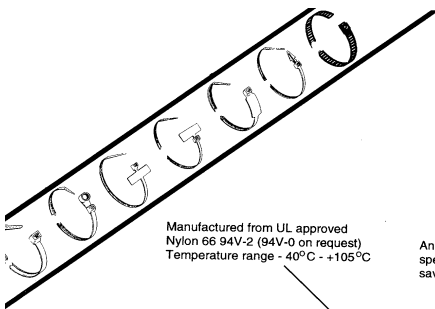

Manufactured from UL approved Nylon 66 94V-2 (94V-0 on request)
Temperature range - 40°C - +105°C

Angled tail for easy and speedy inserting, saving time and money.

Bandex supplies a complete range of specialty application ties as well as a comprehensive array of standard locking ties. Varying in length from 75 mm to 1168 mm and in widths from 2.5 up to an amazing 18 mm

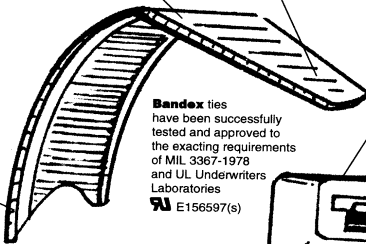

Bandex ties have been successfully tested and approved to the exacting requirements of MIL 3367-1978 and UL Underwriters Laboratories E156597(s)

Unique head and locking design providing maximum tensile strength up to 159 Kgs in our super heavy duty ties

One piece tooling for extra strength

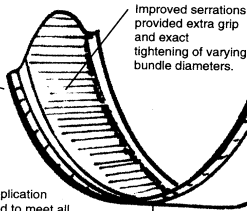

Improved serrations provided extra grip and exact tightening of varying bundle diameters.

Low insertion force required for installation

No matter what type of application **Bandex** ties are designed to meet all kind of extremes in weather changes and temperature fluctuation

Rounded sides no sharp edges

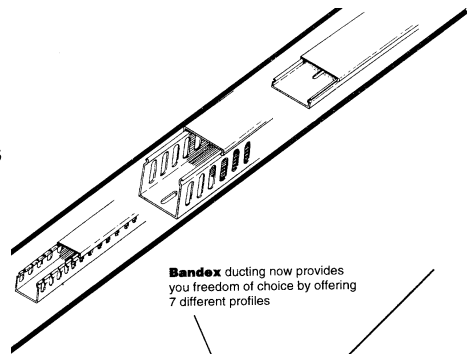
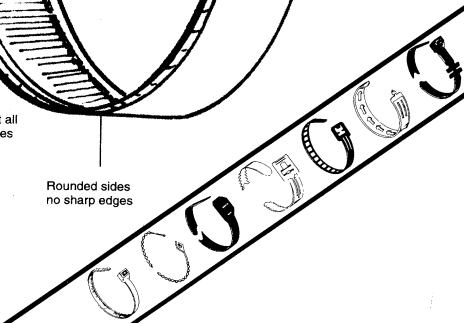

Bandex ducting now provides you freedom of choice by offering 7 different profiles

Bandex ducting provides a wide-range of finger slots from 4 mm to 8 mm closed and solid

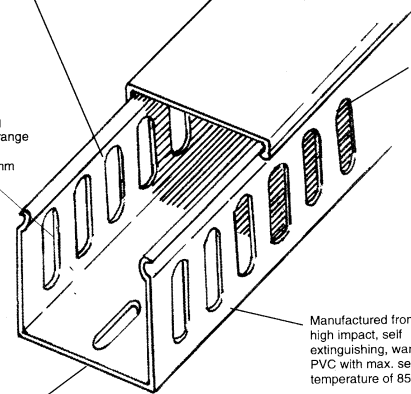

Bandex wiring duct has been tested by the most stringent international standards boasting both UL and CSA approval
UL E156597(s)
LR82854

Manufactured from high impact, self extinguishing, warp proof PVC with max. service temperature of 85°C

Bandex ducting can be supplied with or without fixing slots

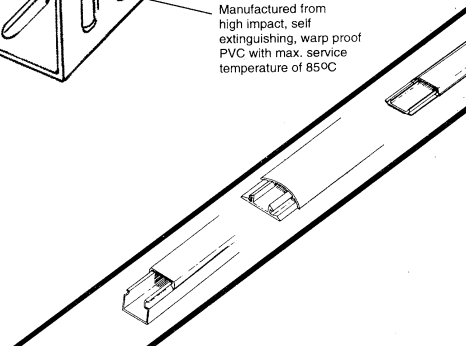



BANDEX

WIRING DUCTS

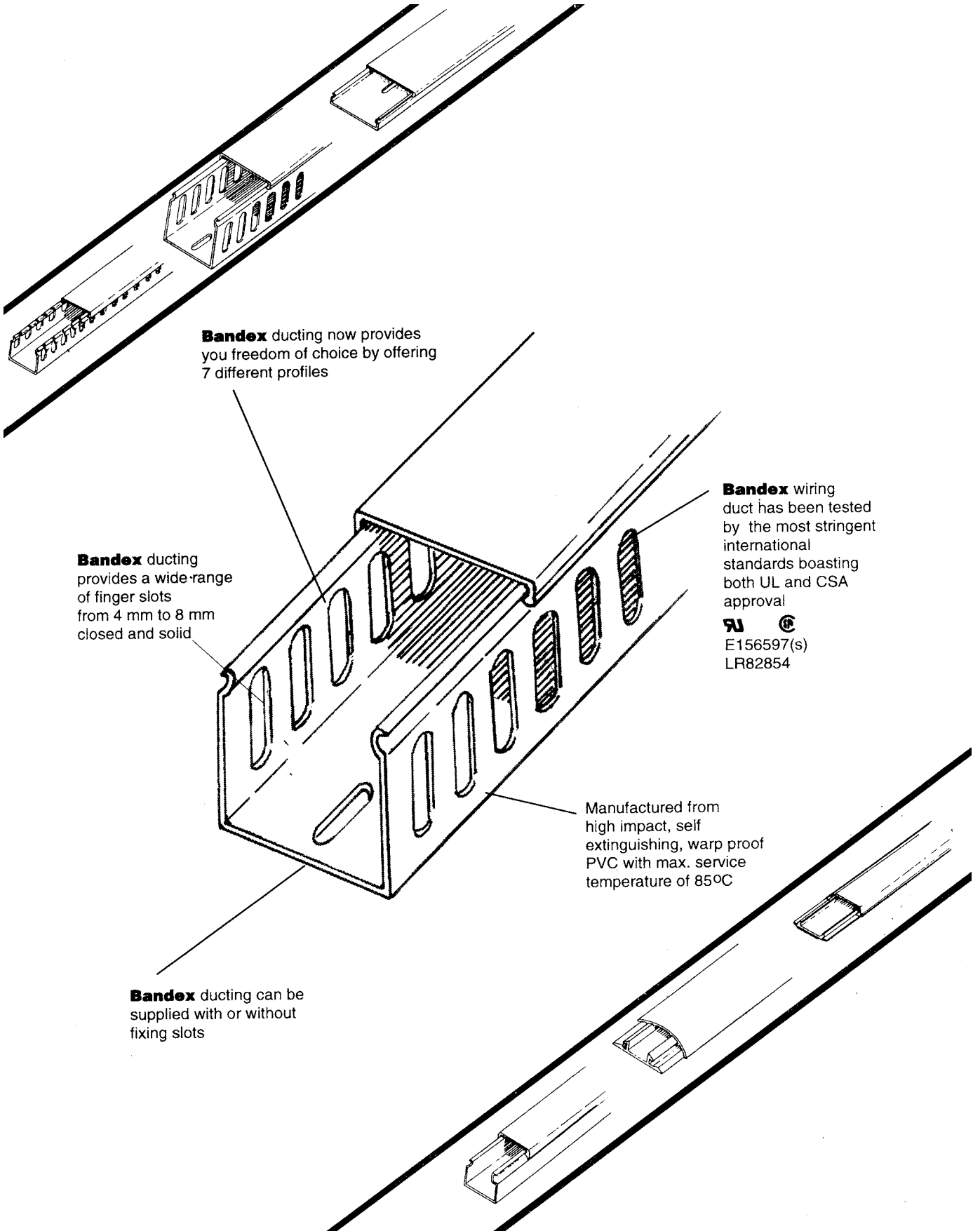

Bandex ducting now provides you freedom of choice by offering 7 different profiles

Bandex ducting provides a wide-range of finger slots from 4 mm to 8 mm closed and solid

Bandex wiring duct has been tested by the most stringent international standards boasting both UL and CSA approval

E156597(s)
LR82854

Manufactured from high impact, self extinguishing, warp proof PVC with max. service temperature of 85°C

Bandex ducting can be supplied with or without fixing slots



KKTC EQUIPMENT Co., Ltd.

Email : Marketing.kktc@gmail.com

Tel.02-044-9685 Fax.02-044-9600

BANDEX P.V.C. WIRING DUCT

TC family wire channel is suitable in the use of wires distribution inside the complete set electrical control equipment and various high and low voltage distributors.

COLOUR : GREY (สีเทา)

SOLID DESIGN

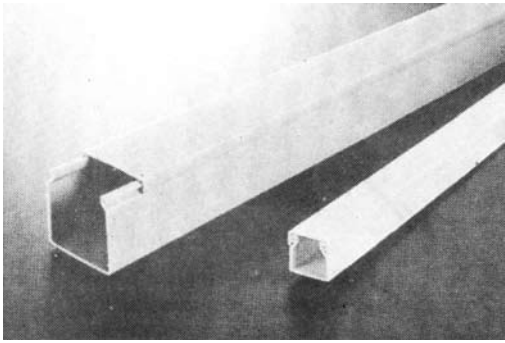

SOLD:

No slot design, for external wiring or where wire extraction is not necessary.

DIMENSION W x H (m.m)	PACKING	ITEM NO.	PRICE
		SLOTTED : O Length 2 M	
25 x 30	72	WD-2530-0	@ n/a
25 x 40	56	WD-2540-0	@ n/a
25 x 60	60	WD-2560-0	@ n/a
30 x 30	70	WD-3030-0	@ n/a
33 x 40	46	WD-3340-0	@ n/a
40 x 40	38	WD-4040-0	@ n/a
40 x 60	28	WD-4060-0	@ n/a
40 x 80	56	WD-4080-0	@ n/a
60 x 40	26	WD-6040-0	@ n/a
60 x 60	18	WD-6060-0	@ n/a
60 x 80	20	WD-6080-0	@ n/a
80 x 60	20	WD-8060-0	@ n/a
80 x 80	16	WD-8080-0	@ n/a
100 x 60	16	WD-10060-0	@ n/a
100 x 100	10	WD-100100-0	@ n/a

COLOUR : WHITE (สีขาว)

ROUND TYPE WIRING DUCT

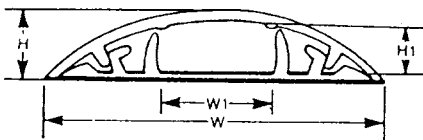

DIMENSION W x H (m.m)	PACKING	ITEM NO.	PRICE
		SLOTTED : O Length 2 M	
25 x 30	72	WD-2530-0	@ n/a
40 x 40	38	WD-4040-0	@ n/a
50 x 50	26	WD-5050-0	@ n/a
60 x 60	18	WD-6060-0	@ n/a
60 x 80	20	WD-6080-0	@ n/a
75 x 40	32	WD-7540-0	@ n/a
100 x 40	36	WD-10040-0	@ n/a
100 x 60	30	WD-10060-0	@ n/a

COLOUR : GREY, MILK, WHITE (สีเทา, ครีม, ขาว)

Item No.	PACKING	W	W1	H	H1	LENGTH	PRICE (ราคา/เส้น)
RD-20	300	20	8	6	4	1 M	@ n/a
RD-30	150	30	11	8	6	1 M	@ n/a
RD-40	100	40	16	9.5	7	1 M	@ n/a
RD-50	65	50	20	11	8	1 M	@ n/a
RD-60	50	60	30	13	9	1 M	@ n/a
RD-70	50	70	40	15	10	1 M	@ n/a

Material : High impact, rigid, self-extinguish P.V.C.

Service temperature : 85°C

Colour : Grey (Milk, White, Brown, Dark Brown available)

Backed with high quality double sided tape for permeant stick. Good for floor wiring to facilitate trolley pass and to avoid trip.

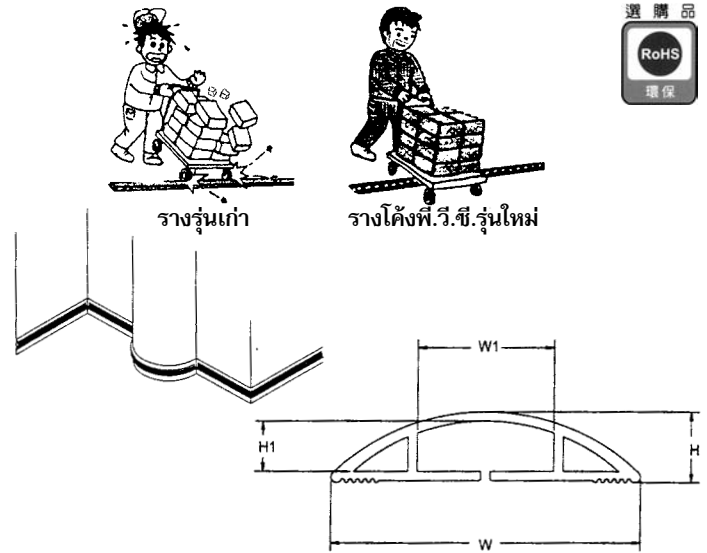
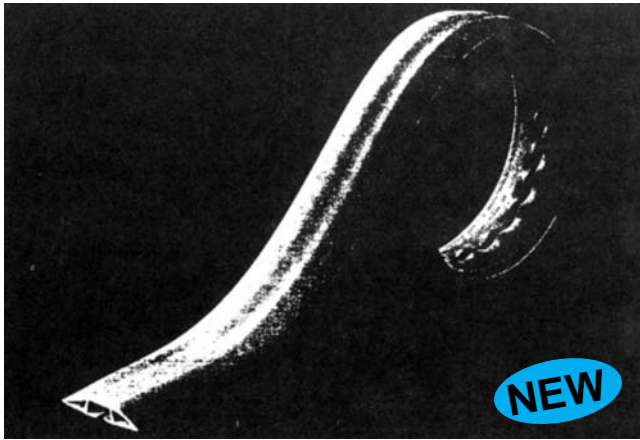
**BANDEX****SOFT WIRING DUCT****วัสดุ**

รางโค้ง พี.วี.ซี

วิธีการใช้

วางสายไฟเข้าไปในร่องรางท่ออ่อนที่ผ่าออกแล้ว (ถ้าต้องการใช้กาวสองหน้า ซ้อนต่างหาก) หลังจากนั้น นำรางท่ออ่อนติดแน่นเข้ากับพื้นหรือผนังกำแพง

จุดเด่น

1. สะดวกต่อการขนย้าย พกพา ติดต่อ
2. ออกแบบเป็นโค้งหลังเต่า (ด้านบน) วางกับพื้นแล้วคนเดินผ่านไม่สะดุดเท้า รถเข็นสามารถผ่านได้สะดวก
3. ตัดโค้งตามความต้องการได้ (ตั้งภาพขวา)
4. เหมาะสำหรับงานชั่วคราว ติดตั้งแล้วสามารถรื้อถอนมาใช้งานใหม่ได้

ITEM NO.	W	W1	H	H1	PACKING	Length	PRICE
SRD-25 เทา	25.4	7.4	5.8	3.8	200 PCS	1 M	@ n/a
SRD-25 น้ำตาล							
SRD-25 ครีม							
SRD-25 ดำ							
SRD-50 เทา	50.8	14.8	11.6	7.8	50 PCS		@ n/a
SRD-50 น้ำตาล							
SRD-50 ครีม							
SRD-50 ดำ							
SRD-65 เทา	66.0	19.0	15.3	10.9	40 PCS		@ n/a
SRD-65 น้ำตาล							
SRD-65 ครีม							
SRD-65 ดำ							
SRD-75 เทา	76.2	22.0	17.4	11.6	35 PCS	@ n/a	
SRD-75 น้ำตาล							
SRD-75 ครีม							
SRD-75 ดำ							
SRD-100 เทา	101.6	29.4	23.2	15.4	20 PCS	@ n/a	
SRD-100 น้ำตาล							
SRD-100 ครีม							
SRD-100 ดำ							

BANDEX WIRING DUCT

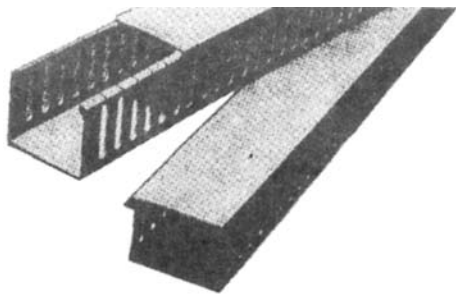

■ 8 mm. SERIES

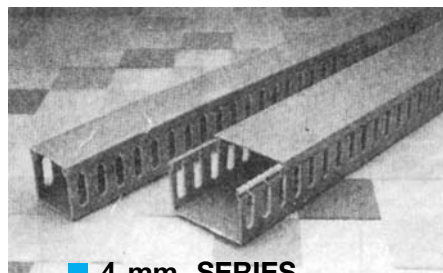
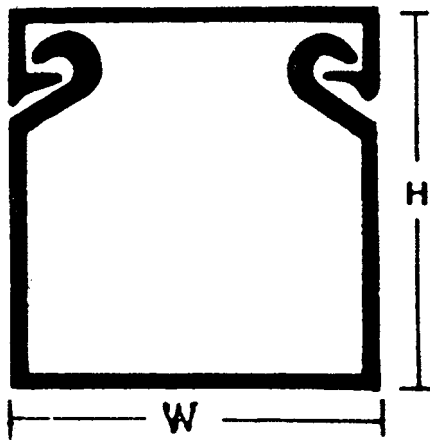
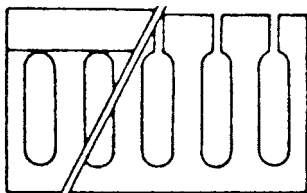

■ 4 mm. SERIES

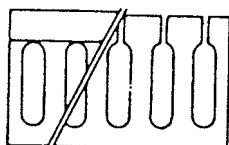

- ◆ Material : High impact, self-extinguishing, warpproof P.V.C. (Polyvinyl chloride)
- ◆ Colour : Grey
- ◆ Maximum service temperature : 80°C
- ◆ Used extensively for all wiring applications
Where cable protection is essential i.e. Switchboards ...etc.
- ◆ Features parallel holes onboth sidewalls to facilitate cutting in wire application.
- ◆ Special colour, size, length upon request of large quantity.

DIMENSION W x H (m.m)	NO. of PACKING	ITEM NO.	PRICE
		SLOTTED : Ø8 mm. Length 2 M	
25 x 30	72	WD-2530-8	@ n/a
25 x 40	56	WD-2540-8	@ n/a
33 x 40	46	WD-3340-8	@ n/a
40 x 40	38	WD-4040-8	@ n/a
60 x 40	26	WD-6040-8	@ n/a
80 x 40	20	WD-8040-8	@ n/a
100 x 40	20	WD-10040-8	@ n/a
25 x 60	42	WD-2560-8	@ n/a
40 x 60	28	WD-4060-8	@ n/a
60 x 60	18	WD-6060-8	@ n/a
80 x 60	20	WD-8060-8	@ n/a
100 x 60	16	WD-10060-8	@ n/a
120 x 60	12	WD-12060-8	@ n/a
120 x 65	12	WD-12065-8	@ n/a
25 x 80	28	WD-2580-8	@ n/a
40 x 80	28	WD-4080-8	@ n/a
60 x 80	20	WD-6080-8	@ n/a
80 x 80	16	WD-8080-8	@ n/a
100 x 80	12	WD-10080-8	@ n/a
120 x 80	10	WD-12080-8	@ n/a
40 x 100	24	WD-40100-8	@ n/a
70 x 100	14	WD-70100-8	@ n/a
100 x 100	10	WD-100100-8	@ n/a

DIMENSION W x H (m.m)	NO. of PACKING	ITEM NO.	PRICE
		SLOTTED : Ø4 mm. Length 2 M	
15 x 25	150	WD-1525-4	@ n/a
20 x 20	140	WD-2020-4	@ n/a
25 x 25	88	WD-2525-4	@ n/a
25 x 45	54	WD-2545-4	@ n/a
25 x 65	40	WD-2565-4	@ n/a
30 x 30	70	WD-3030-4	@ n/a
33 x 33	54	WD-3333-4	@ n/a
33 x 45	40	WD-3345-4	@ n/a
33 x 65	30	WD-3365-4	@ n/a
45 x 45	30	WD-4545-4	@ n/a
45 x 65	24	WD-4565-4	@ n/a
50 x 50	26	WD-5050-4	@ n/a
60 x 60	18	WD-6060-4	@ n/a
65 x 45	20	WD-6545-4	@ n/a
65 x 65	16	WD-6565-4	@ n/a

DECORATION WIRING DUCT.

選購品

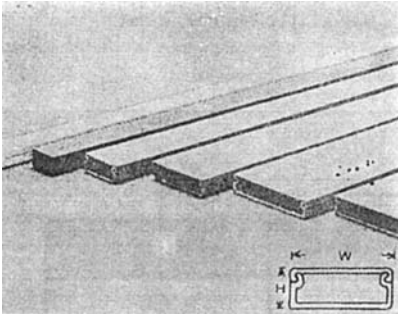

- ◆ Material : Rigid, self-extinguishing P.V.C.
- ◆ Standard colour : Grey, (Milk, White, Brown available upon request to meet your colour system.)
- ◆ Features : All size feature same height in 11 mm which were specially designed for flat cables.
- ◆ Application : Used extensively for electric wire application of indoor decoration or outdoor security, alarm system.

มีสีเทา ขาว ครีมน

ITEM NO.	PACKING	Overall Length	Width (m.m.)	Height (m.m.)	Price ราคา/เส้น
TE-1	340	2 M	12.7 (1/2")	11	@ n/a
TE-2	200	2 M	19.1 (3/4")	11	@ n/a
TE-3	170	2 M	25.4 (1")	11	@ n/a
TE-4	130	2 M	31.8 (1 1/4")	11	@ n/a
TE-5	110	2 M	38.1 (1 1/2")	11	@ n/a
TE-6	80	2 M	50.8 (2")	11	@ n/a

TELEPHONE WIRING DUCT (SELF-ADHESIVE)

選購品

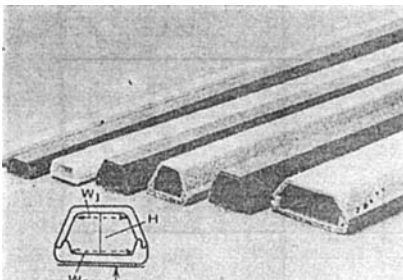

- ◆ Material : Rigid, self-extinguishing P.V.C.
- ◆ Backed with high quality self-adhesive tape to facilitate wire application.
- ◆ colour : Grey, (Milk, White, Brown available on request)
- ◆ Length : 2 M
- ◆ Application : Designed to protect wire on floor.

มีสีเทา ขาว ครีมน

ITEM NO.	PACKING 1 M	PACKING 2 M	DIMENSION			Wire to be Contained	Price ราคา/เส้น	
			W1	W2	H		1 M	2M
TP-1	100	350	6	7	4	1 pcs	15.-	@ n/a
TP-1.5	80	200	-	-	-	3-4 pcs	-	-
TP-2	55	190	8	8	6	3 pcs	21.-	@ n/a
TP-3	45	140	10	10	10	3-4 pcs	27.-	@ n/a
TP-4	60	90	12	15	13	4-7 pcs	34.-	@ n/a
TP-5	50	75	10	17	16	7-9 pcs	37.-	@ n/a
TP-6	40	60	11	19	16	10-15 pcs	47.-	@ n/a
TP-8	30	32	30	37	16	30-40 pcs	115.-	@ n/a

選購品

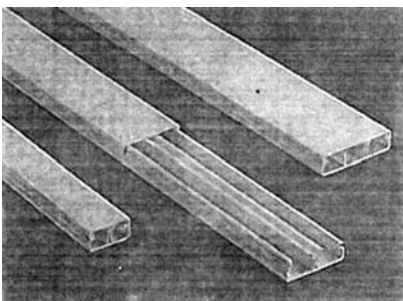

Item No.	Length	W (m.m.)	W1	W2	W3	H	PACKING	Price ราคา/เส้น
WD-2010-2	2 M	20.0	7.5	7.5		10.3	260	@ n/a
WD-3010-2		30.0	12.5	12.5		11.2	150	@ n/a
WD-4010-3		40.0	11	11.5	11.5	10.3	130	@ n/a

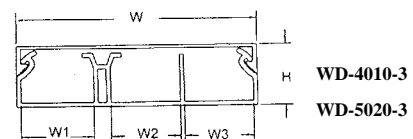
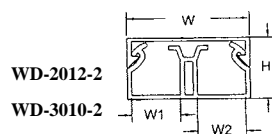

BANDEX WIRING DUCT

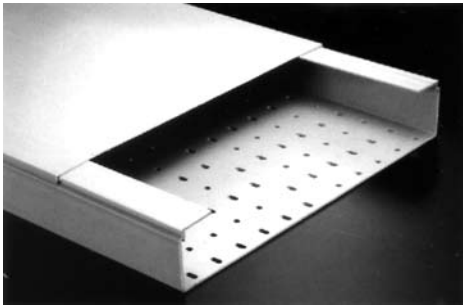

**Material : High impact, self-extinguishing, warp-proof,
UL approved 94V-0 PVC (grey)
Maximum service temperature : 85°C**

- ◆ Features : With special design in hook and base slot. To work with L design of coupler, it makes the conjunction of wiring ducts stronger, smooth and neatly. Easier and faster in installation.
- ◆ Fixing slot on duct base can vaporize the heat arised from cables faster. Suitable for cables used in big project.

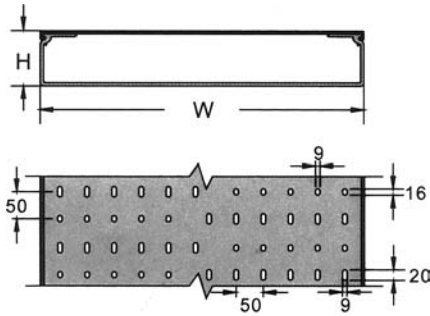

Item No.	W x H (mm)	Wires to be contained (calculated by 2.0 mm)	Length (mm)
SDH-400100	400 x 100	1380~1600pcs	3M
SDH-600100	600 x 100	2080~2400pcs	

BANDEX WIRING DUCT COUPLER

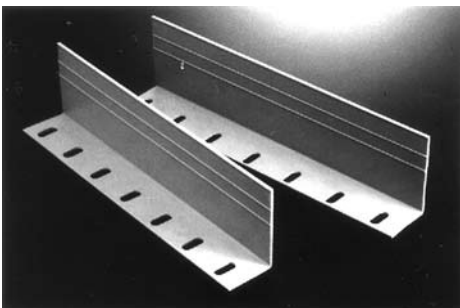

**Material : High impact, self-extinguishing, warp-proof,
UL approved 94V-0 PVC (grey)
Maximum service temperature : 85°C**

- ◆ Available for fixing with plastic screw PF823HNGYJ and nut PN8HNGYJ

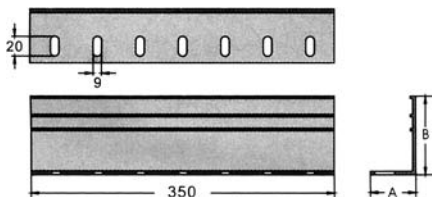

Item No.	A (mm)	B (mm)	Length (mm)	Used with
DCP-100	40.5	75.5	350	SDH-400100 SDH600100

Material : PP (Black)

- ◆ All sizes in mm unless otherwise stated.
- ◆ ID or OD can vary +0.4 mm
- ◆ Manufactured from P.P. (Black)
- ◆ Cut to requested length available
- ◆ Please contact our office with your requirements.

unit : mm

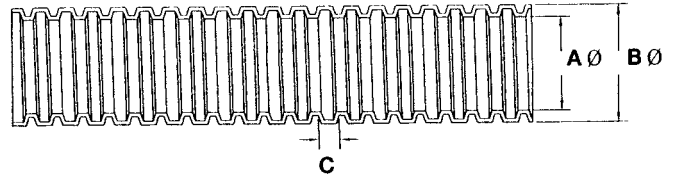

Part No.		Inner dia	Outside dia	C	Packing	Price
Split design	Close design	AØ (mm)	BØ (mm)	10.0	17.9	
CR-07P	CRS-07P	7.4±0.4	10.2±0.4	2.60	300M	@ n/a
CR-11SP	CRS-11SP	10.7±0.4	14.0±0.4	1.10	200M	@ n/a
CR-11P	CRS-11P	10.7±0.4	16.0±0.4	3.30		@ n/a
CR-13P	CRS-13P	13.8±0.4	17.5±0.4	3.10		@ n/a
CR-15P	CRS-15P	15.0±0.4	19.5±0.4	3.50	100M	@ n/a
CR-17P	CRS-17P	17.2±0.4	22.0±0.4	3.10		-
CR-19P	CRS-19P	19.3±0.4	23.8±0.4	3.50		@ n/a
CR-22p	CRS-22P	21.2±0.4	25.8±0.4	3.10		@ n/a
CR-24P	CRS-24P	24.3±0.4	32.0±0.4	3.61	50M	-
CR-25p	CRS-25P	25.0±0.4	30.0±0.4	4.10		@ n/a
CR-28P	CRS-28P	28.0±0.4	34.0±0.4	3.10		@ n/a
CR-32P	CRS-32P	31.2±0.4	40.0±0.4	4.12		-
CR-35P	CRS-35P	34.9±0.4	42.0±0.4	3.10		-
CR-40P	CRS-40P	39-6±0.5	50.0±0.5	4.85		-
CR-48P	CRS-48P	47.5±0.4	54.5±0.5	2.00		-
*CR-52P	CRS-52P	52.0±0.5	60.0±0.5	5.80		-
*CR-62P	CRS-62P	62.0±0.5	76.0±0.5	5.80	-	
*CR80P	CRS-80P	80.0±0.5	89.0±0.5	5.80	-	

* Please call if required as it is under developing now

BANDEX CABLE MARKERS

MARKER PLATE

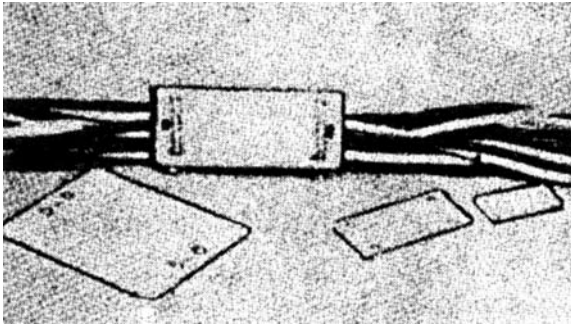

- ◆ Material : Nylon (Natural)
- ◆ Used to mark cable bundles for permanent identification.
- ◆ Secured with cable ties extensively from CT-075 to CT-200 in variety of ways.

Item No.	L (m/m)	W	T	PACKING	PRICE ราคา/ตัว
MP-1626	26	16	0.8	100 pcs/bag	@ n/a
MP-2040	40	20	1		@ n/a
MP-2560	60	25	1		@ n/a
MP-5060	60	50	1		@ n/a

SELF-ADHESIVE WIRE MARKERS (CLOTH TYPE)

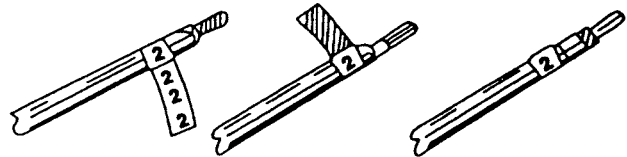
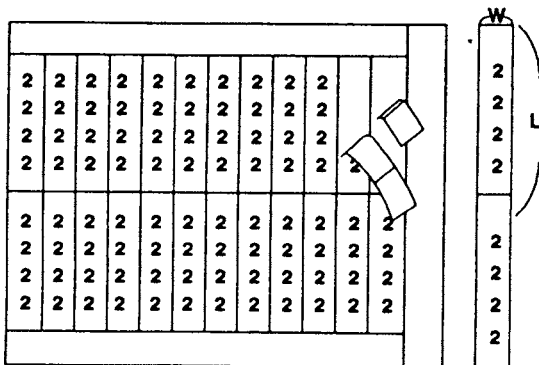

SOLID NUMBER



SOLID LETTER

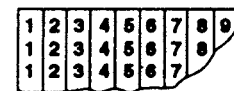

CONSECUTIVE NUMBERS



CONSECUTIVE LETTERS Unit m/m

- ◆ Stick to wire for permanent identification.
- ◆ Used extensively for cable diameters after or before terminal is attached.
- ◆ Cloth type label.
- ◆ For your orders, please specify solid or consecutive and what letter (S), number (S) you need.

For example:

Solid : WM-1 1, 2, A, B 10 pcs each.
 Consecutive : WM-1 0-9, A-Z 10 pcs each.

ITEM NO.	L	W	Standard Marking	Standard Marking	PRICE ราคา/แผ่น
SM-1	25	6.5	Solid numbers 0, 1, 2, 3 99, 100 A, B, C.... Z, +, - Consecutive Numbers 1-34, 35-68, 69-100 A-Z, 0-9	50 pcs / Box	@ n/a

BANDEX CABLE MARKERS

BM TYPE CABLE MARKERS

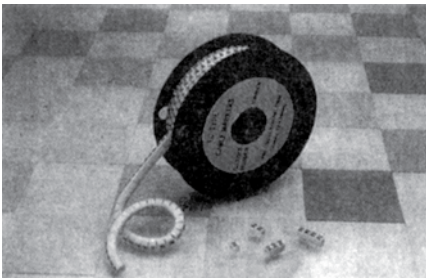



- ◆ Marker tongue spans to fit various cable diameters and retracts to hold wire firmly in position.
- ◆ Maximum service temperature : 85°C
- ◆ MATERIAL : Made of finest soft grade, strong, durable P.V.C. that will resist oil, grease, acid, abrasion and chemicals.

Description

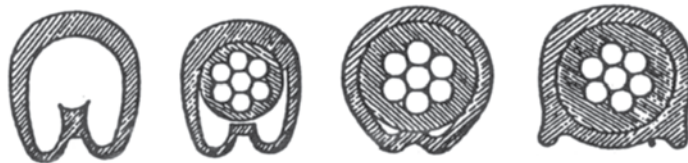
- ◆ EC type cable marker features high quality flexible interior to fit various cable diameters.
- ◆ The markers stay attached on a roller and can be despatched easily when needed.
- ◆ Bold print on yellow body to show your codes distinguishly. Any numbers can be composed by arranging letters and numbers in sequence to provide the necessary codes.
- ◆ To be fitted before the terminal is attached or solder connection made and grip cables firmly in position.

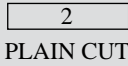

SHAPE	ITEM NO.	DIA. RANGE M.M. MIN MAX	STANDARD MARKING	STANDARD PACKING	STANDARD MARKING	PRICE ราคา/ม้วน
 PLAIN CUT 	BM - 0	2.0 - 3.2	SOLID NO OR LETTER PER ROLL FOR 0, 1, 2, 3 ...9 A, B, C, ...Z +, -, + - BLANK / (SLANG)	1,000 pcs	YELLOW BODY WITH BLACK PRINT	@ n/a
	BM - 1	3.0 - 5.2		1,000 pcs		@ n/a
	BM - 2	3.6 - 7.4		500 pcs		@ n/a
	BM - 3	5.2 - 10.0		250 pcs		@ n/a

MARKER STRIP

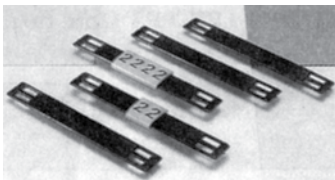

CAT. NO	STRIP SIZE	STRIP HOLE	ACCOMMODATE MARKERS	PACKING	PRICE ราคา/ตัว
MS-65	65 x 9	6	9 pcs GM-1	100 pcs	@ n/a
MS-100	100 x 9	6	16 pcs GM-1		@ n/a



OVALGRIP MARKER

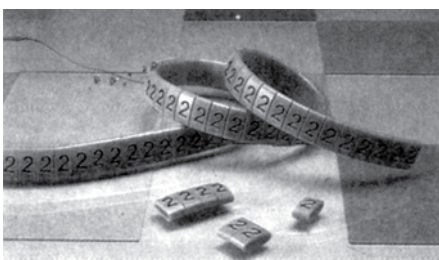

CAT. NO	SUITABLE CABLES USED WITHOUT MARKER STRIP	MARKER LENGTH	MARKING	PACKING	PRICE ราคา/ม้วน
GM-1	3.5-7.0	5	0, 1, 2, 3 ...9 A, B, C, ...Z +, -, /, EARTH, BLANK	500 pcs/rl	@ n/a

BANDEX CABLE TIES

WIRE COLLECTTIE

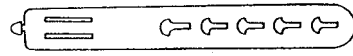

TL-1

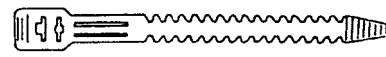

PV-160-9C



PV-130-15C



PV-140-9C

- ◆ Wrap electrical cords for shipping and packing.
- ◆ Inexpensive.
- ◆ Material : Polyethylene.
- ◆ Colour : Clear

Part No.	Size	Tensile	Max. Bundle	Price
	mm	Strength	mm	
PV-130-15C (TL-1)	130 x 15	8	35	@ n/a
PV-140-9C	140 x 9	8	45	
PV-160-9C	160 x 9	8	38	@ n/a

SELF-ADHESIVE TIE MOUNTS

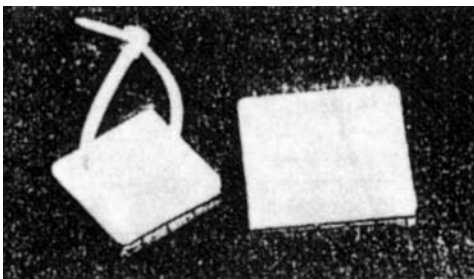

- ◆ Material : Constructed of nylon and backed with high quality self-adhesive type.
- ◆ SELF-ADHESIVE TIE MOUNTS is designed to support Light Weight wire bundles when properly applied on any clean, smooth, grease-free surface. For heavey support. Mounting Hole is provided for screws.
- ◆ To apply, simply peel off backing paper and apply Mount To surface, After that, cable ties can inseted to secure wire bundles.

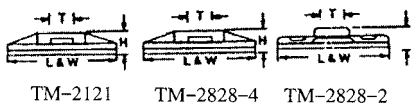

Item No.	L	W	H (Without tape)	Mounting	T	Packing	PRICE ราคา/ตัว
TM-2121-4	21	21	3.5	-	4.7	100	@ n/a
TM-2828-4	28	28	4	5.0	5.0	pcs/bag	@ n/a

SADDLE TYPE TIE MOUNTS

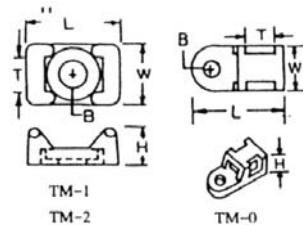

MATERIAL: Nylon in natural color.
Saddle design provide maximum stability to wire bundles.
To apply, simply fix mount with a screw and secure wire bundles with nylon cable ties.

Item No.	H	L	W	T	B	Packing	Price ราคา/ตัว
TM - 0	5	19	9.5	5	3.4	100 pcs/bag	@ n/a
TM - 1	7	15	10	5	3		@ n/a
TM - 2	9	23	16	9	5		@ n/a



Cable Ties and Accessories

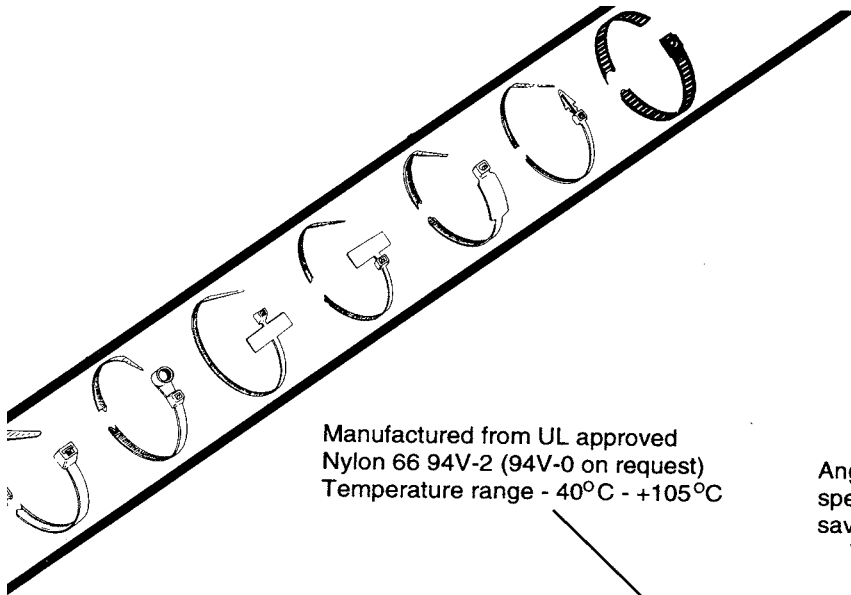

Manufactured from UL approved Nylon 66 94V-2 (94V-0 on request)
Temperature range - 40°C - +105°C

Angled tail for easy and speedy inserting, saving time and money.

Bandex supplies a complete range of specialty application ties as well as a comprehensive array of standard locking ties. Varying in length from 75 mm to 1168 mm and in widths from 2.5 up to an amazing 18 mm

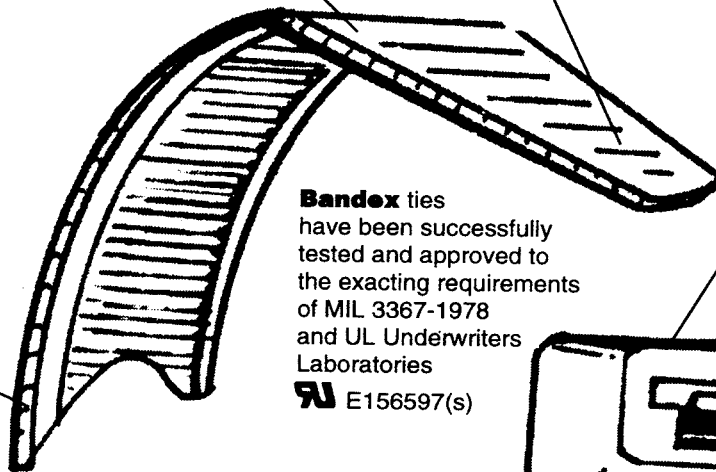

Bandex ties have been successfully tested and approved to the exacting requirements of MIL 3367-1978 and UL Underwriters Laboratories E156597(s)

Unique head and locking design providing maximum tensile strength up to 159 kgs in our super heavy duty ties

Low insertion force required for installation

One piece tooling for extra strength

Improved serrations provided extra grip and exact tightening of varying bundle diameters.

No matter what type of application **Bandex** ties are designed to meet all kind of extremes in weather changes and temperature fluctuation

Rounded sides no sharp edges

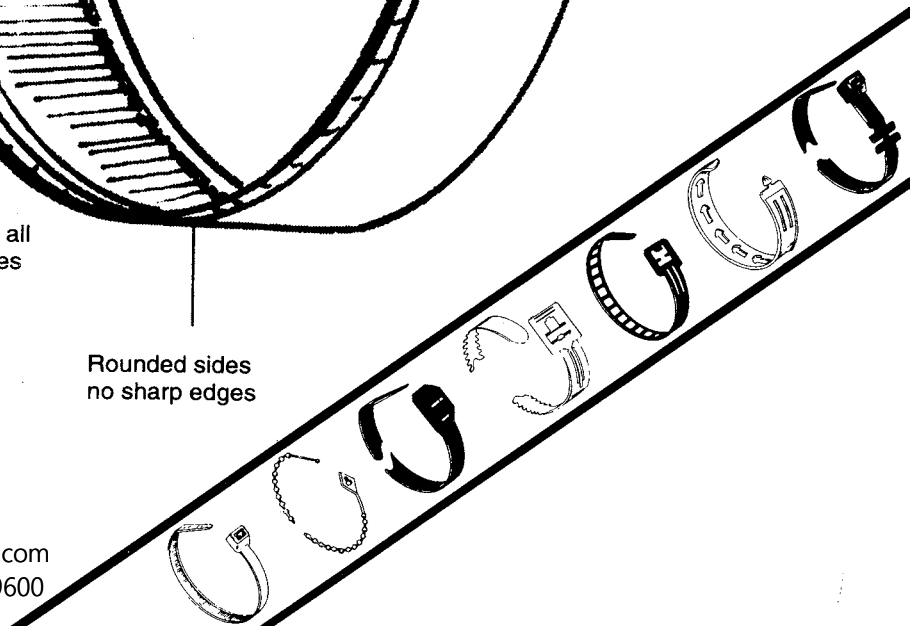

BANDEX CABLE TIES

MATERIAL SPECIFICATION :

Natural nylon : standard cable ties made from U.L. Approved nylon 6/6.
 Normal service temperature range :- 10°C to 85°C.
 Flamablility rating : 94 V-2

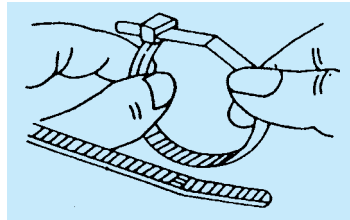
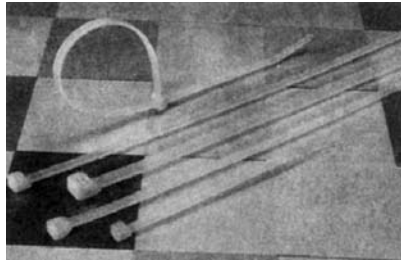

Bent-tip design for ease of handling and installation

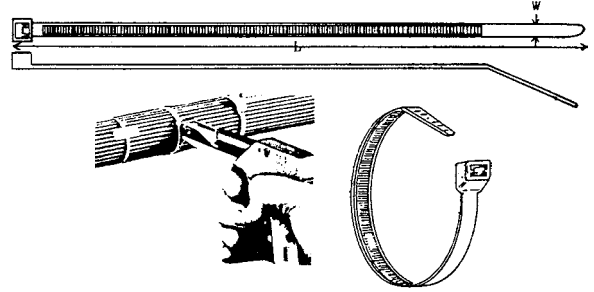

ITEM NO สีขาว White Colour	ITEM NO สีดำ Black Colour	L		W (mm)	Max. Bundle die (mm.)	Min. Tensile Strength		Packing Per/bag	Packing Per/box	Price ราคา/เส้น (สีขาว) White Colour	Price ราคา/เส้น (สีดำ) Black Colour
		(mm.)	(Inch)			Ibs	Kgs				
CT-075-2C1	CT-075-2B1	75	3"	2.5	18	18	8	100 pcs	60,000	@ n/a	@ n/a
CT-100-2C2	CT-100-2B2	100	4"	2.5	25	18	8		60,000	@ n/a	@ n/a
CT-120-2C	CT-120-2B	120	4 3/4"	2.5	30	18	8		50,000	@ n/a	@ n/a
CT-120-3C	CT-120-3B	120	4 3/4"	3.2	30	40	18		32,000	@ n/a	@ n/a
CT-140-3C	CT-140-3B	140		3.2					28,000	@ n/a	@ n/a
CT-150-3C	CT-150-3B	150	6"	3.6	39	40	18		25,000	@ n/a	@ n/a
CT-180-4C	CT-180-4B	180	7"	4.0	49	50	22		17,000	@ n/a	@ n/a
CT-190-4C	CT-190-4B	190		4.8					13,000	@ n/a	@ n/a
CT-200-3C	CT-200-3B	203	8"	3.2	55	40	18		22,000	@ n/a	@ n/a
CT-200-4C	CT-200-4B	203	8"	4.6	55	50	22		13,000	@ n/a	@ n/a
CT-250-4C	CT-250-4B	250	10"	4.8	74	50	22		12,000	@ n/a	@ n/a
CT-280-4C	CT-280-4B	280	11"	4.8	81	50	22		10,000	@ n/a	@ n/a
CT-300-7C	CT-300-7B	300	11 7/8"	7.6	88	120	55		5,000	@ n/a	@ n/a
CT-310-4C	CT-310-4B	310	12"	4.8	89	50	22		10,000	@ n/a	@ n/a
CT-340-7C	CT-340-7B	340	13 1/2"	7.6		120	55		5,000	@ n/a	@ n/a
CT-380-7C	CT-380-7B	380	15"	7.6	110	120	55		4,500	@ n/a	@ n/a
CT-385-4C	CT-385-4B	385	15 3/16"	4.8	116	50	22		9,000	@ n/a	@ n/a
CT-550-8C	CT-550-8B	550	21 11/16"	8.0	16				2,500	@ n/a	@ n/a
CT-610-9C	CT-610-9B	610	24"	9.0	185				2,000	@ n/a	@ n/a
CT-710-9C	CT-710-9B	710	28"	9.0	220				1,800	@ n/a	@ n/a
CT-762-9C	CT-762-9B	762	30"	9.0	236			1,000	@ n/a	@ n/a	
CT-812-9C	CT-812-9B	812	32"	9.0	246			1,000	@ n/a	@ n/a	
CT-914-9C	CT-914-9B	914	36"	9.0	270			1,500	@ n/a	@ n/a	
CT-1168-9C	CT-1168-9B	1168	46"	9.0	360			1,100	@ n/a	@ n/a	
CT-1219-9C	CT-1219-9B	1219	48"	9.0	380			1,000	@ n/a	@ n/a	

MOUNT TIES

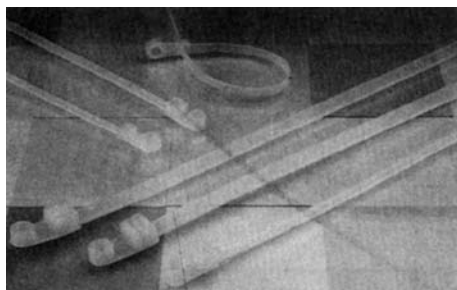

For application where fixation of cable bundle is required

Item No.	Old Item No	mm.	mm.	Max. Bundle Dia	Min. Tensile Strength	Packing	Price ราคา/เส้น
MT-155-3C	CV-155	155	3.7	40	40 lbs	100 pcs	@ n/a
MT-205-4C	CV-205	205	4.2	60	50 lbs		@ n/a

- ◆ Material : Nylon 6/6 specifications as same as former page.
- ◆ Color : Natural white (Available in black)
- ◆ The cable tie can be secured to panel with a single bolt.



Unit : mm

MARKER TIE

Cat. NO	Size	Marker size	Bundle diameter	Tensile strength	Packing	PRICE
MV-100-2C	100 x 2.5	25 x 8	25	18 lbs	100 pcs	@ n/a
MV-200-4C	200 x 4.8	28 x 13	50	50 lbs		@ n/a

MV-100-2C 1.40

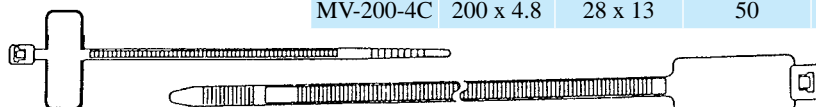

MV-200-4C 2.00





■ NK (Nc) TYPE

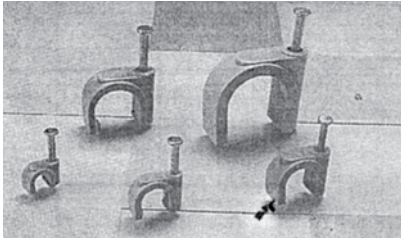

- ◆ Material : Impact Resistant P.P. (Grey)
- ◆ Applied for general round cables.
- ◆ With nails.
- ◆ NC Type Without Nails Been Deleted. All Clips Are Now With Nails And Item No Were Changed Into Ie. NC-1 N N Means With Nails. And It Is Equal To NK-6.

ITEM NO	W (m.m.)	NAIL (m.m.)	Standard Packing	Price ราคา/ตัว
NK-4 (NC-0.4N)	4	2.5 x 18	100 pcs	@ n/a
NK-6 (NC-1N)	6	2.5 x 18		@ n/a
NK-8 (NC-2N)	8	2.5 x 22		@ n/a
NK-10 (NC-3N)	10	2.5 x 25		@ n/a
NK-12 (NC-4N)	12	2.5 x 27		@ n/a
NK-14 (NC-6N)	14	3.0 x 35		@ n/a
NK-16 (NC-7N)	16	3.2 x 38		@ n/a
NK-22 (NC-8N)	22	3.2 x 42	100	@ n/a
NK-25 (NC-9N)	25	3.2 x 47	100	@ n/a
NK-32 (NC-10N)	32	3.6 x 56	50	@ n/a



■ CLAMP & MOUNTS

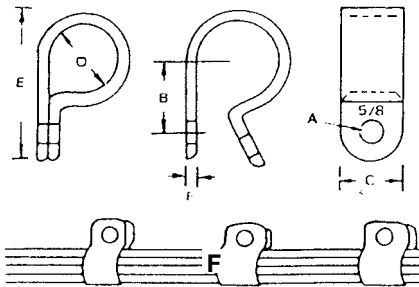
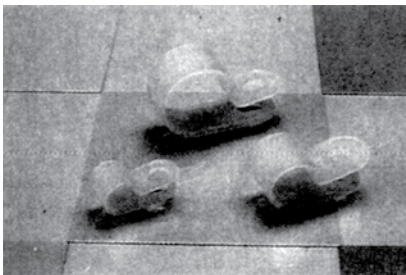

CABLE CLAMP

- ◆ MATERIAL : Nylon (Natural) Max. service temp. : 80°C
- ◆ CABLE CLAMP are designed to holed cables, tubes, and component in domestic appliance, electronics and electric apparatus generally.
- ◆ Interion edges are radiused to protect cable insulation.
- ◆ To apply, just clamp down on loosen cable and screw to chassis.
- ◆ Black color available



Item No.	A	B	C	D	E	F	Packing	Price ราคา/ตัว
CC-03	5.0	9.5	9.6	3.2 (1/8")	19.8	1.4	100 pcs	@ n/a
CC-05	4.6	10.5	9.6	4.8 (3/16")	19.8	1.4		@ n/a
CC-06	5.0	12.0	10.0	6.7 (1/4")	22.0	1.4		@ n/a
CC-08	4.6	12.0	10.0	7.9 (5/16")	22.0	1.5		@ n/a
CC-10	4.6	15.2	12.0	9.5 (3/8")	24.0	1.5		@ n/a
CC-13	4.6	12.5	12.0	12.7 (1/2")	31.0	1.5		@ n/a
CC-16	4.6	18.2	12.0	15.8 (5/8")	34.3	1.5		@ n/a
CC-19	4.6	18.2	12.0	19.4 (3/4")	35.0	1.5		@ n/a
CC-25	4.6	22.0	12.0	25.4 (1")	43.0	1.8		@ n/a
CC-32	4.6	26.2	12.0	31.8 (1 1/4")	46.2	1.8		@ n/a
CC-38	4.6	30.0	12.0	36.7 (1 1/2")	50.0	1.8		@ n/a

■ CABLE CLAMP

SELF-ADHESIVE CABLE CLAMP

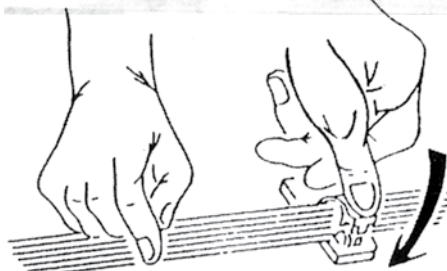
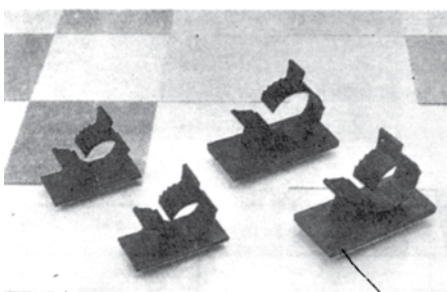

- Material: Nylon (Black)
- Backed with a high quality pad. Designed to secuer wire bundles where Fixing holes are impactical. Can be quickly applied to almost any clean, (Also provided with a mounting hole)

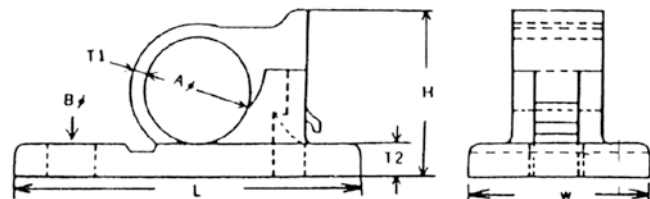

Item No	A Ø	B Ø	T1	T2	L	W	H	Packing	Price
4p-s	6	4.4	1.1	2	25.8	13.4	9.1	100 PCS	@ n/a
6p-s	9	4.4	1.1	3	29.4	13.4	14.0		@ n/a
8p-s	12	4.4	1.5	3	35.5	16.4	16.5		@ n/a
10p-s	14	4.4	1.5	3	36.5	16.4	18.5		@ n/a
11p-s	16	4.4	1.5	3	38.5	16.4	20.5		@ n/a
12p-s	18	4.4	1.5	3	42.0	16.4	22.5		@ n/a

BANDEX HEAT SHRINKING SLEEVE

HEAT SHRINKING SLEEVE

R: RED W: White BL:Blue B: Black G: Green Y: Yellow

- Material: Rigid Shrinkable P.V.C.
- Used for colour distinction and insulation of busbar in control panel. To be shrinked by blower or hot water.
- Maximum service temp : 80°C

SPIRAL WRAPPING BAND

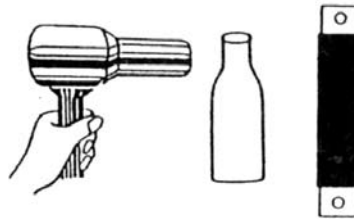

Item No.	LAY FLAT Dimension	Convert to Dia Ø	Shrinkable Range	Colour	Pkg	Price ราคา/ม้วน
HS-20	20	13	21 - 11	R,W,B,BK,Y,G	100 เมตร	@ n/a
HS-30	30	19	31-16	R,W,B,BK,Y,G		@ n/a
HS-40	40	25	40-22	R,W,B,BK,Y,G		@ n/a
HS-50	50			R,W,B,BK,Y,G		@ n/a
HS-60	60	38	60-33	R,W,B,BK,Y,G		@ n/a
HS-70	70	44	70-37	R,W,B,BK,Y,G		@ n/a
HS-80	80	50	80-42	R,W,B,BK,Y,G		@ n/a
HS-100	100	63	100-55	R,W,B,BK,Y,G		@ n/a
HS-120	120	76	120-65	R,W,B,BK,Y,G		@ n/a
HS-150	150	95	150-90	R,W,B,BK,Y,G		@ n/a

CAT. No.	FOR COPPER BUS BAR/SIZE
HS-20	1/2" x 1/8", 3/16" x 1/2" A, 1/2" x 1/4"
HS-30	3/4" x 1/8", 3/4" x 3/16", 3/4 x 1/4", 1" x 1/8", 1" x 3/16"
HS-40	1 1/4" x 1/8", 1/14 x 3/16", 1 1/4" x 1/4", 1 1/2" x 1/8"
HS-50	1 1/4" x 1/4", 1 1/2" x 3/16", 1 1/2" x 1/4, 1 1/2" x 3/8"
HS-60	2" x 1/8", 2" x 3/16", 2" x 1/4", 2" x 3/8", 2" x 1/2"
HS-70	2 1/2" x 1/8", 2 1/2" x 3/16", 2 1/2" x 1/4"
HS-80	2 1/2" x 3/8", 3" x 1/4", 3" x 3/8", 3" x 1/8"
HS-100	3" x 3/16", 3" x 1/4", 3" x 3/8", 3" x 1/2"

CLOSE END WIRE CONNECTOR

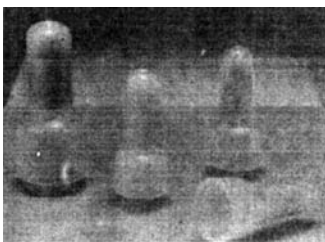

CAT. No.	Ø1	Ø2	Ø3	L1	L2	NORMINAL SECTIONAL AREA	A.W.G	SUITABLE WIRE	PACKING	PRICE ราคา/ตัว
								STRAING mm ² d		
CE-1	2.4	7.8	5.1	7.5	20.0	1.25	22 - 16	0.5 - 1.75	100 pcs	@ n/a
CE-2	3.0	7.8	5.7	7.5	20.0	2.0	16 - 14	1.0 - 3.0		@ n/a
CE-5	3.8	10.5	7.3	8.5	25.3	5.5	12 - 10	2.5 - 6.0	100 pcs	@ n/a
CE-8	4.7	12.0	9.3	9.5	27.2	8.0	8.0	4.0 - 9.0		@ n/a

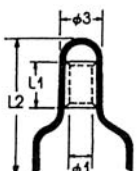

- The above size will be changed without notice if necessary.
- Material: UL approved NYLON 66,94v-2. • Nylon insulated close-end wire connectors.
- To apply, insert pre-stripped wires into connector tube and crimp it with crimping tool to hold wires firmly even in vibration.

VINYL WIRE END CAPS

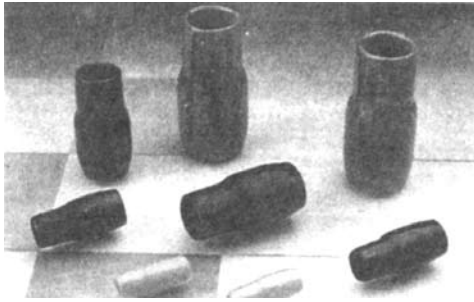

- Material: Soft P.V.C
- Maximum service temp: 80°C
- For the insulation works of wire end terminal. Performing the work with a simple one-touch to tighten and seal against. Dirt, moisture and water.
- Standard color : Red, white, blue, yellow, black. (Green, brown available on special request)

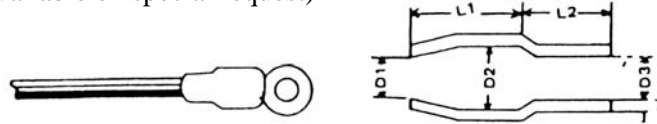

Item No	Wire Suitable	D1	D2	D3	L1	L2	T	Packing	Price
VC-001	600V 1.25 mm ² , 12.5 mm ²	2.8	3.3	3.1	6	7	0.6	100 PCS	@ n/a
VC-002	600V 2.0 mm, 2.0 mm ² , 1.2 mm ² , Single, 1.6 mm Single	3.3	4.5	3.7	7	7	0.7		@ n/a
VC-003	600V 3.5 mm ²	4.8	5.7	4.1	9	8	0.8		@ n/a
VC-005	600V 5.5 mm ² , 2.6 mm Single	4.8	5.7	5.2	9	8	0.8		@ n/a
VC-008	600V 8.0 mm ² , 3.2 mm Single	6.2	7.2	6.2	10	9	1.0		@ n/a
VC-014	600V 14 mm ²	8.0	10.0	8.0	13	11	1.1		@ n/a
VC-022	600V 22 mm ²	9.5	12.0	9.5	15	14	1.2		@ n/a
VC-038	600V 38 mm ²	11.8	14.0	11.8	17	16	1.5		@ n/a
VC-060	600V 60 mm ²	13.5	16.8	13.5	20	19	1.5		@ n/a
VC-080	600V 80 mm ²	16.0	19.0	16.0	25	21	1.6		@ n/a
VC-100	600V 100 mm ²	18.0	22.0	18.0	30	24	1.7	50 PCS	@ n/a
VC-125	600V 125 mm ²	20.0	24.0	20.0	32	25	1.8		@ n/a
VC-150	600V 150 mm ²	22.0	24.4	22.0	34	31	1.81		@ n/a
VC-200	600V 200 mm ²	28.0	32.0	24.0	35	30	2.0	20 PCS	@ n/a
VC-250	600V 250 mm ²	32.0	36.0	25.0	40	35.5	2.0		@ n/a
VC-325	600V 325 mm ²	34.3	38.0	28.5	40	36.5	2.01		@ n/a

SPIRAL WRAPPING BAND

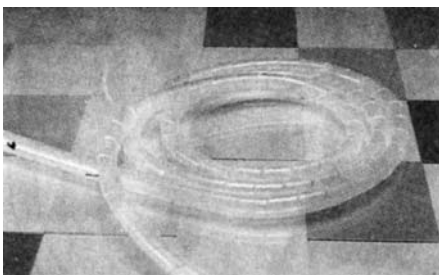

- ◆ MATERIAL : Made from P.E. material.
- ◆ Excellent in insulation and binding strength.
- ◆ Color : Standard in natural. Black and color available upon request.
- ◆ Flexible construction enables bands to follow wire ways easily.
- ◆ Durable, reusable with retained spiral strength.

Item No.	Item No. Black สีดำ	D	D1	W	Wrapping Range (mm.)	Packing	Price ราคา/เมตร	
							สีขาว	สีดำ
SW-06	SW-06B	4	6	7.0	4 - 50	10 m per plastic bag	@ n/a	@ n/a
SW-08	SW-08B	6	8	10.8	6 - 60		@ n/a	@ n/a
SW-10	SW-10B	7.5	10	11.4	7.5 - 60		@ n/a	@ n/a
SW-12	SW-12B	9	12	13.9	9 - 65		@ n/a	@ n/a
SW-15	SW-15B	12	15	15	12 - 75		@ n/a	@ n/a
SW-19	SW-19B	15	19	18.2	15 - 100		@ n/a	@ n/a
SW-24	SW-24B	20	24	19.6	20 - 130		@ n/a	@ n/a

- ◆ Fix ends of band with cable ties and spiral wire bundles in clockwise direction to complete works.
- ◆ Expand spiral range almost without limit.
- ◆ Black color available.

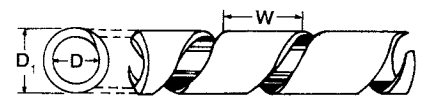

An economical way of cable binding. Easily applied to electric harness cables and wire bundles. Cut-to-fit versatility in convenient roll-form.

BANDEX SLIT WRAPPING BAND

SLIT WRAPPING BAND

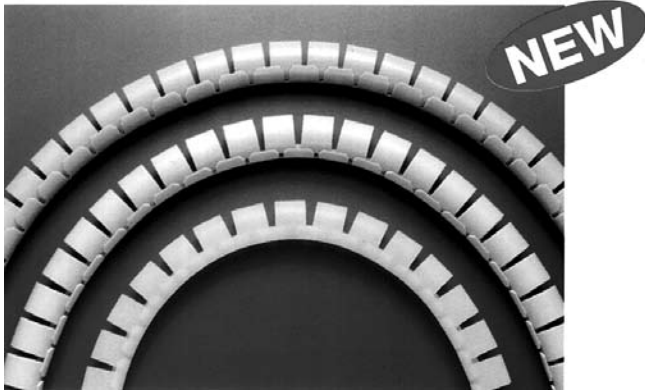

Item No	D	T	W	Wrap- ing Range	Packing	Price
XX-XXX	8	0.8	9	10	5M	
XX-XXX	15	0.8	13	16		
XX-XXX	20	0.9	15	22		
XX-XXX	25	1.3	18	27		
XX-XXX	32	1.3	23	35		

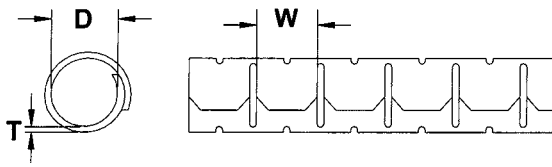

SLIT WRAPPING BAND INSTALLATION TOOL

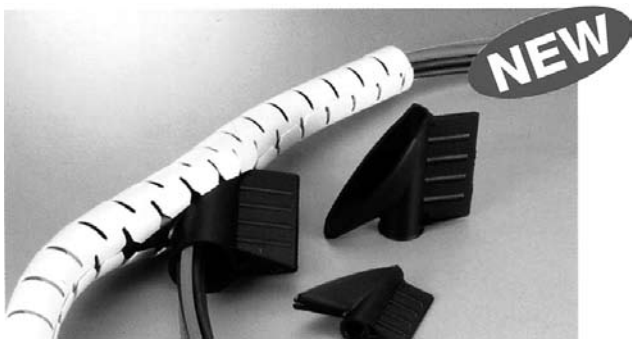

Item No	D	To Be Used with	Packing	Price
XX-XXX	8	KL-8BK	10 PCS	
XX-XXX	15	KL-15BK		
XX-XXX	22	KL-20BK		
XX-XXX	26	KL-25BK		
XX-XXX	32	KL-32BK		

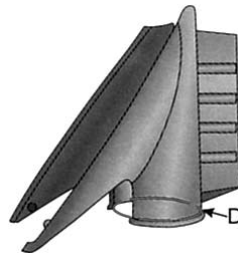
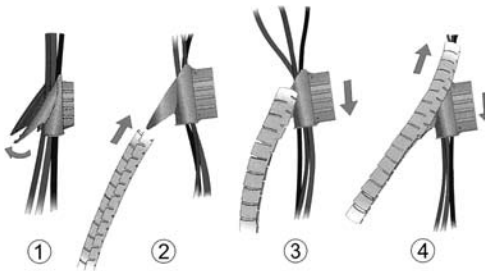

SLIT WRAPPING BAND WITH INSTALLATION TOOL



Item No	D	T	W	Wrapping Range	Packing	Price
XX-XXX	8	0.8	9	10	1.5M	
XX-XXX	15	0.8	13	16		
XX-XXX	20	0.9	15	22		
XX-XXX	25	1.3	18	27		
XX-XXX	32	1.3	23	35		

BANDEX SNAP BUSHING & HOLE PLUG

SNAP BUSHING

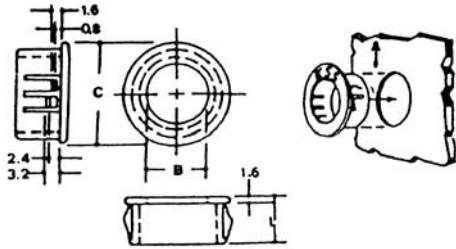
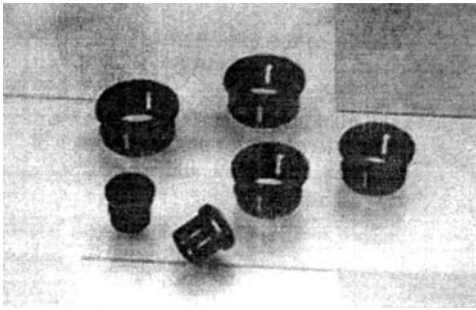

- Material: Nylon(Black)
- SNAP BUSHING smooth and insulate your raw-edged holes in metal chassis
- Locking into hole firmly with fingertip pressure.
- Protect electrical cables, ropes, utility lines through metal holes.
- Available in application for chassis thickness from 0.8 mm to 3.2 mm



Item No.	Mounting Hole				Pack Qty	PRICE
	mm					
	A	B	C	L		
SB-08	7.9	5.2	9.4	8.0	100 pcs	@ n/a
SB-10	9.5	6.3	12.0	10.3		@ n/a
SB-13	13.0	8.2	14.5	10.3		@ n/a
SB-16	15.9	12.2	18.6	10.3		@ n/a
SB-19	18.9	14.3	21.5	10.3		@ n/a
SB-22	22.0	17.3	23.8	11.5		@ n/a
SB-26	25.1	19.1	28.0	11.5		@ n/a
SB-30	29.7	24.1	32.5	11.5		@ n/a
SB-38	38.1	29.0	41.2	11.4		@ n/a

HOLE PLUGS

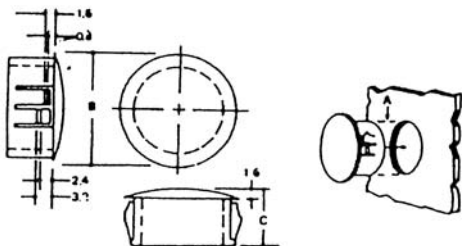
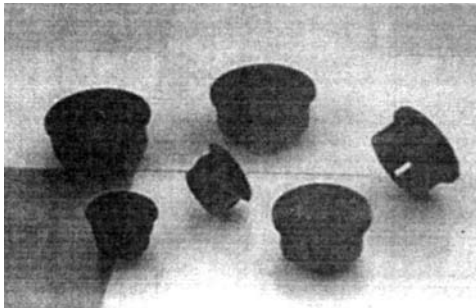

- Material: Nylon(Black)
- HOLE PLUG close your unneeded holes with fingertip pressure at own cost and assure good appearance.
- Available in application for chassis thickness from 0.8 mm to 3.2 mm.



Item No.	Mounting Hole			Pack Qty	PRICE
	mm				
	A	B	C		
HP-08	8.0	11.9	8.0	100 pcs	@ n/a
HP-10	10.0	13.0	10.5		@ n/a
HP-13	13.0	16.9	10.5		@ n/a
HP-16	16.0	19.8	10.5		@ n/a
HP-19	19.0	22.9	10.5		@ n/a
HP-22	22.0	24.9	11.3		@ n/a
HP-25	25.0	28.3	11.5		@ n/a
HP-30	30.0	34.2	11.5		@ n/a
HP-45	44.5	49.1	11.1		@ n/a

MOVABLE BUSHING

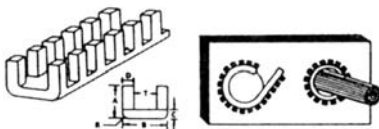

- **STANDARD**
 1. P.E. Extruded movable bushing.
 2. 10M per roll packed in a plastic bag.
 3. Cut to fill any hole size for protecting cords, wires, cables against damage from sharp panel edges.
- Available upon request
Also available in moulded PE bushing.
25 cm per piece and 40pcs packed per bag.
For your order, please specify MOULDED MOVABLE BUSHING.
Otherwise, will be treated as standard ones.



Part No.	T	Max. Chassis	Packing	Material	Price
	mm	Thickness			
		mm			
MB-010	1	1	10 m.	P.E.	@ n/a
MB-016	1.6	1.0-1.6			@ n/a
MB-020	2	1.6-2.0			@ n/a
MB-024	2.4	2.0-2.4			@ n/a
MB-032	3.2	2.4-3.2			@ n/a
MB-045	4.5	3.2-4.5			@ n/a

BANDEX GLANDS AND BUSHINGS

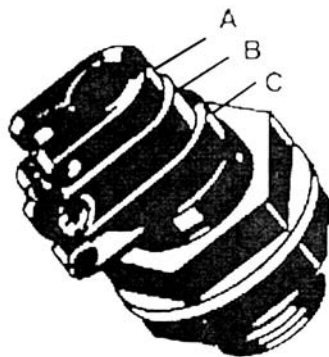

Part No.	To Suite Panel Hole mm	To Suite Cable Die. mm			Length of Thread mm	Packing Qty	Price
		A	B	C			
BG-19	19	6	8	10	13	50	@ n/a
BG-22	22	10	13	15	17.5	50	@ n/a

Manufactured from soft pvc (black)
 Interior diameter of each gland is available in three sizes A,B,C
 Cut unnecessary part (s) away to fit your different cable diameters.

STANDARD

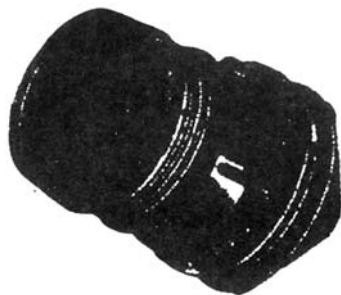

Part No.	Thread mm	For Cable dia.	Length of Thread	Packing Qty	Price
NG-16	16 x 1.5	5 - 10	12	80	@ n/a
NG-20	20 x 1.5	6 - 13	13	50	@ n/a
NG-25	25 x 1.5	10 - 18	13	50	@ n/a
NG-32	32 x 1.5	16 - 22	15	25	@ n/a
NG-40	40 x 1.5	22 - 27	21	10	@ n/a
NG-50	50 x 1.5	30 - 41	23	10	@ n/a
NG-63	63 x 1.5	40 - 53	25	10	@ n/a

SUPREME-METRIC IP68



Part No.	Thread mm	For Cable dia.	Length of Thread	Packing Qty	Price
AG-12	12 x 1.5	3 - 6.5	8	50	@ n/a
AG-16	16 x 1.5	5 - 10	15	50	@ n/a
AG-20	20 x 1.5	10 - 14	15	50	@ n/a
AG-25	25 x 1.5	13 - 18	15	50	@ n/a
AG-32	32 x 1.5	18 - 25	15	25	@ n/a
AG-40	40 x 1.5	22 - 32	18	10	@ n/a
AG-50	50 x 1.5	30 - 38	18	10	@ n/a
AG-63	63 x 1.5	34 - 44	18	10	@ n/a
AG-63L	60.5 x 1.9	34 - 44	20	10	@ n/a

SUPREME-PG THREAD IP68



Part No.	Thread mm	For Cable dia.	Length of Thread	Packing Qty	Price
EG-7	PG-7	3 - 6.5	8	50	@ n/a
EG-9	PG-9	4 - 8	8	50	@ n/a
EG-11	PG-11	5 - 10	8	50	@ n/a
EG-13.5	PG-13.5	6 - 12	15	50	@ n/a
EG-16	PG-16	10 - 14	15	50	@ n/a
EG-21	PG-21	13 - 18	15	50	@ n/a
EG-29	PG-29	18 - 25	18	25	@ n/a
EG-36	PG-36	22 - 32	18	10	@ n/a
EG-42	PG-42	30 - 38	18	10	@ n/a
EG-48	PG-48	34 - 44	18	10	@ n/a